

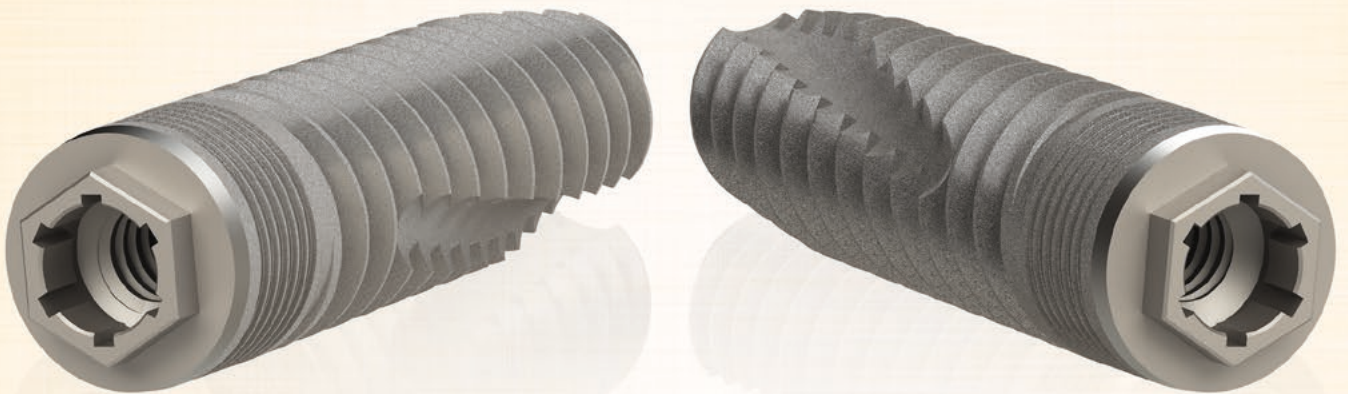

VULKAN
DENTAL IMPLANTS

Vulkan® External Hex. Implant System



ALL IN ONE

AVAILABLE IMPLANT SYSTEMS



INTERNAL
HEX.



EXTERNAL
HEX.



CONICAL
CONNECTION

V/BODY

Índice

Vulkan® External Hex. Implant System

About us	3
Vulkan® Internal Hex. Implant	
Implant Design and Properties	4-5
VLA® Surface Treatment and Plasma Cleaning	6
Sizes Guide	7
Technical Specification	8-9
Surgical Protocol	10-11
Implant Driver and Packaging	12
Step-by-Step Implant Placement	13-14
Vulkan® Internal Hex. Prosthetic Solutions and Tools	
Introduction	16
Main Components	17-18
Transepithelial Multi-Use® System	19-20
Overdenture VulkanLoc® System	21
CAD-CAM Components	22
Surgical and Prosthetic Tools	23-24
How we work	
Innovation, Precision and Quality	25
Science - Scientific committee	26
Clinical Cases	27

Designed and made in **Barcelona**,
one of the most advanced cities
in the world in biotechnology



About us

Vulkan® is a modern, cutting-edge **European dental implant brand**, established in **Barcelona** (Spain) in 2013.

Vulkan® was born out of our long and recognized expertise in the field of dental implantology. Also, because of our links with highly regarded companies and professionals in the sector and our close ties with the strong and world-renowned local biotechnological network.

As a manufacturer of implants and dental prosthetic solutions, our added value is based on the **high quality and reliability** of our processes and products. As well as the innovative capacity of our team of scientists, engineers and dental professionals.

In **Vulkan®** we carefully monitor and control all our processes of R+D+i, design, production and quality to be able to guarantee 100% the success of our products.

Our mission is to improve and facilitate the experience of the patients and dental health professionals by designing, manufacturing and making more accessible the most up-to-date dental implant technology.

Innovation:

The constant improvement and the desire to find the best solutions for the patients place us as an innovative and reliable company.

Quality:

Quality and seeking perfection are golden rules for everything we do.

Commitment:

Our commitment with the patients: solutions that improve their quality of life.
Our commitment with the industry professionals: innovations to improve their clinical experience.

Added value:

The engine that moves us forward is the motivation to always offer more and better solutions.

Sustainability:

For us sustainability is a core value in our decision making process, to enable our values and our brand to last over time.

Vulkan® Internal Hex., the most innovative design with the latest technology in each area of the implant

Polished coronal region

Polished and beveled surface of 0.5 mm.

Aids the **proper healing** of the perimplantary mucogingival tissue, promoting the **hygiene** in the supracrestal area.

Hinders the adhesion of bacterial plaque.

Diminishes the risk of perimplantitis.

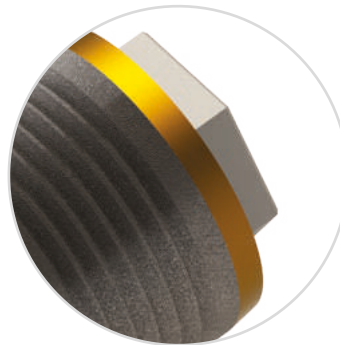

Micro-slot in cortical area

High primary stability at the cortical level.

Suitable for **immediate loading** treatments with bone types III and IV.

Decrease of occlusal loading **stress**.

Reduces the risk of cortical bone resorption.

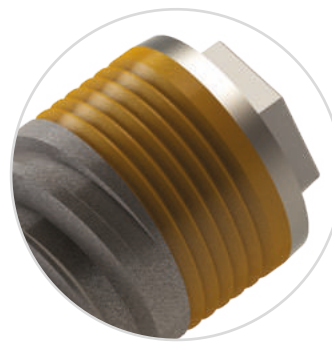

Double thread

High advance of 1.8 mm per revolution.

Easy insertion.

Precise conicity to enable **gradual** condensation of the bone, **facilitating primary stability**.



Cutting notches

Self-tapping.

Optimal channeling of the detached tissue during implantation.

Anti-rotational function after **osseointegration**.

Reduce excessive pressure on the alveolar bone during insertion.

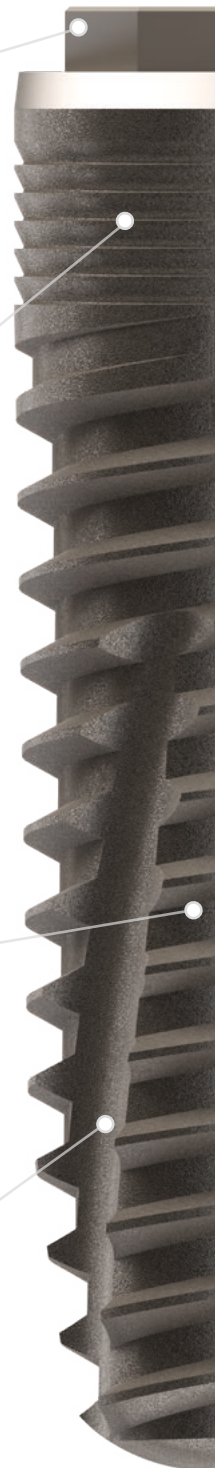

External Hexagon Connection

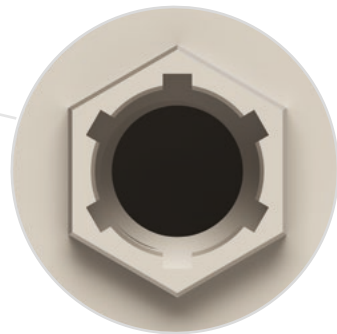

Wide **compatibility**.

Maximum **simplicity**.

Prosthetic comfort.

Trapezoidal thread profile

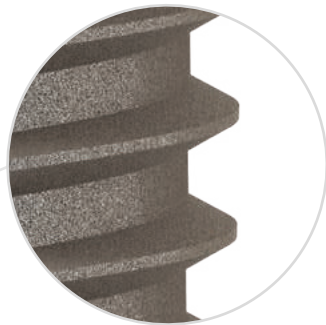

Optimal load distribution.

Facilitates **self-tapping** function.

Extensive bone contact surface.

Atraumatic tapered apex



Facilitates self-tapping to **improve maneuverability**.

Blunt tip **minimizes the risk of injuring**
anatomical structures.

Simulates the **natural tooth root**.

VLA® Surface treatment

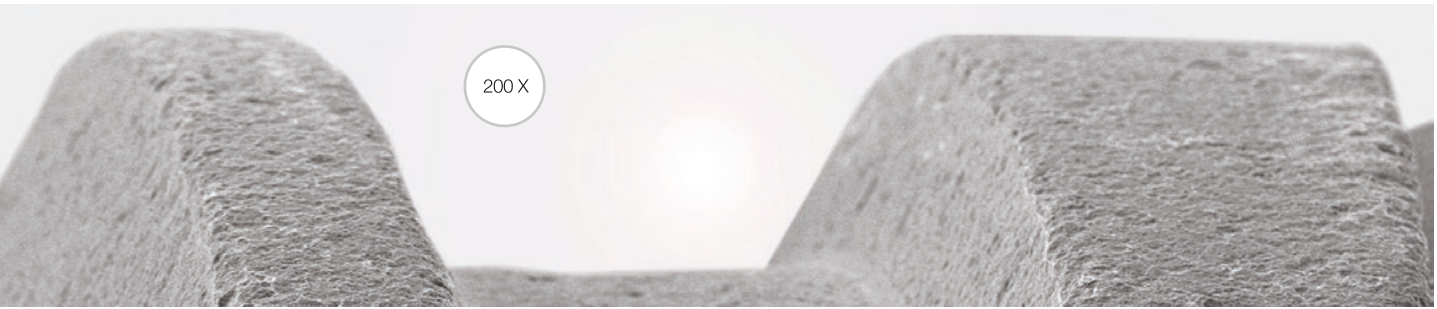

Proven Guarantee of Success

The Vulkan® EXT-HEX implant has been subjected to a treatment consisting of **sandblasting + double acid etching** creating a surface with optimum roughness of 1.4 μm .

This is a widely studied surface that provides a microstructure that **stimulates the osseointegration** of the implant.

The **VLA®** surface treatment presents **success rates of 98%-99%**. This microstructure also ensures a large contact area between implant and bone, providing the **maximum BIC (Bone Implant Contact)**.

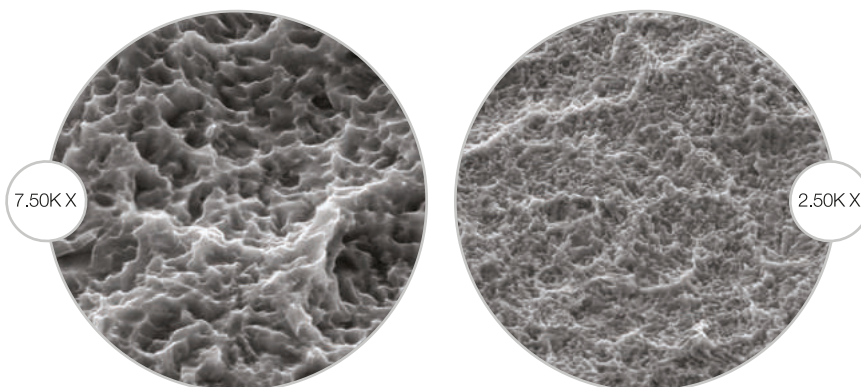

The Cleanest Implant

In addition, an **innovative final cleaning technique** is applied using a **plasma** cleaning system that strikes the surface of the implant, subjecting it to an intensive blasting causing the detachment and **complete elimination of any possible remaining contaminants**.

Finally, the implant is subjected to a strict **sterilization** by gamma rays.

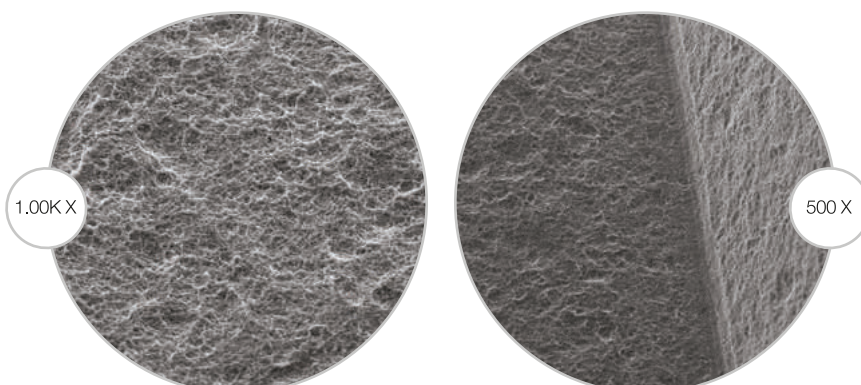

Vulkan® External Hex., the cutting-edge implant that meets all your needs



Ø3.3 NP

NP



3.30x08 3.30x10 3.30x11,5 3.30x13 3.30x15



Ø3.75 RP

RP



3.75x08 3.75x10 3.75x11,5 3.75x13 3.75x15 3.75x18



Ø4.2 RP

RP



4.20x06 4.20x08 4.20x10 4.20x11,5 4.20x13 4.20x15 4.20x18



Ø5.0 RP

RP



5.00x06 5.00x08 5.00x10 5.00x11,5 5.00x13 5.00x15

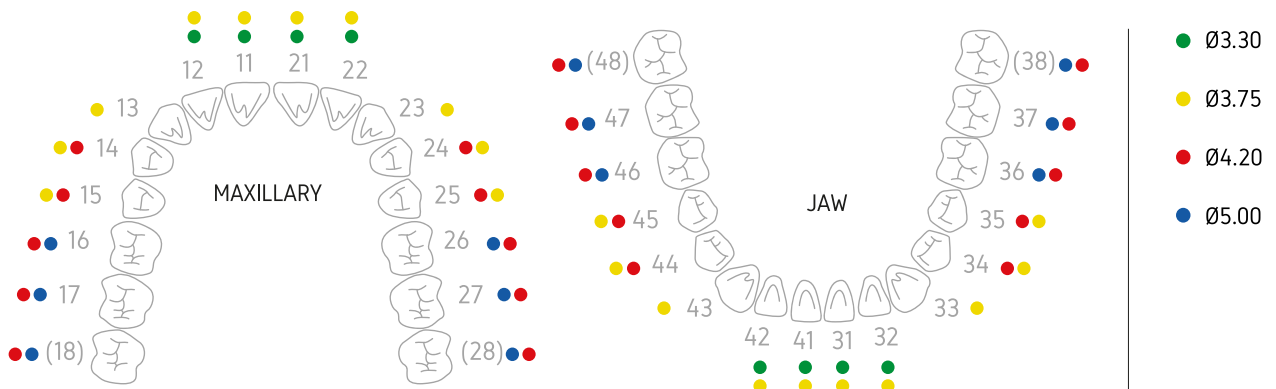

* All Vulkan® External Hex. Implants include the Cover Screw VEXTNTC (NP) or VEXTRTC (RP) in the same pack.

Technical specifications

Vulkan® External Hex.

NP

Platform: 3.5
Hexagon: 2,40
Metric: M-1.6



NP: Narrow Platform

RP: 3 diameters, 1 single platform

RP

Platform: 4.1
Hexagon: 2,70
Metric: M-2

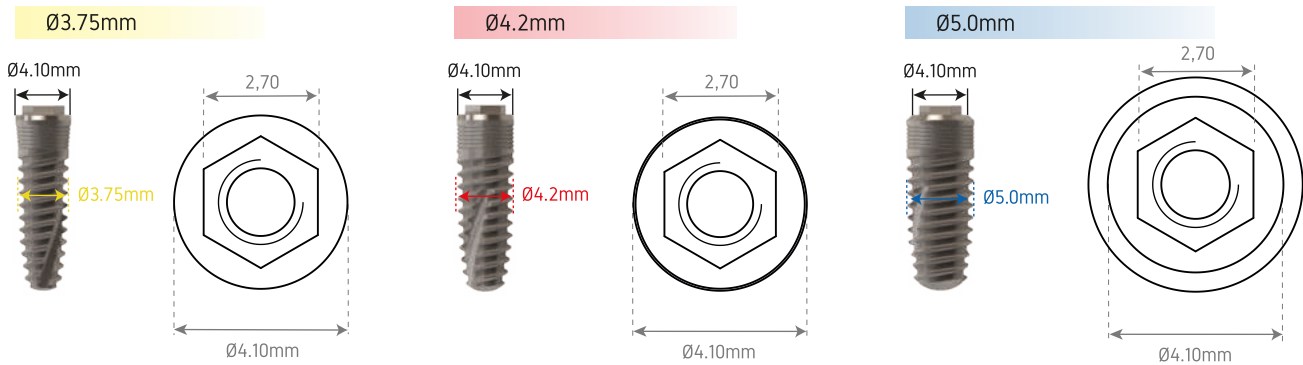

Technical specifications

Vulkan® Internal Hex.

The best titanium for the most advanced implant

In general, scientifically-proven dental implants are made of Titanium Grade 4. This material is known for providing better biocompatibility than Titanium Grade 5, because it has more pure titanium. However, although Titanium Grade 5 is less biocompatible, it has superior mechanical properties than Titanium Grade 4. This is the reason why Titanium Grade 5 is most commonly used in prosthetic components and Titanium Grade 4 in implants.

The determining factor in choosing between one material or another is their biocompatibility. However, it is also very important that the material contains mechanical properties that provide tensile/shear resistance, elasticity and enough strength/hardness to withstand the prosthetic process satisfactorily. That is why, in Vulkan we use an innovative material that provides the same biocompatibility than Titanium Grade 4 and the same mechanical properties than Titanium Grade 5.

How do we manage to obtain the best of both materials in one?

Technically, the composition of our Titanium is Grade 4. However, when forming it we use a “Cold Forming” technique. This process to form the material is what provides our implants their superior mechanical properties.

Using this innovative technique, we manage to produce our implants for maximum biocompatibility and the best possible mechanical properties.

Vulkan® Grade 4 titanium “Cold forming”

- ✓ Higher strength
- ✓ Greater Biocompatibility
- ✓ Advanced Mechanical Properties

Comparison of the different compositions of titanium

Titanium		Mechanical characteristics		
Description	State	Tensile strength N/mm ²	0,2% Yield point N/mm ² min.	Elongation %
Grade 2		345	230	20
Grade 3		450	300	18
Grade 4		550	440	15
Grade 4 MCW	Medical Cold Worked	800-900	> 700	> 10

Surgical Protocol

Vulkan® Internal Hex.

These indications have been made for guidance (only).
Bone drilling must be done carefully and taking into account the different bone density characteristics (Type I-IV).

Important considerations (to be taken) during bone drilling

- Use copious/profuse external irrigation of pre-refrigerated NaCl at 5°C solution.
- Prepare the implant bed site with sequential drilling (straight up-and-down motion during osteotomy).
- Drill the osteotomy using light pressure.

Recommended drill speed:
(Must be individualised based on the bone density type)

Pilot Drill	850 r.p.m.
Drill 2.5	800 r.p.m.
Drill 2.8	750 r.p.m.
Drill 3.2	650 r.p.m.
Drill 3.65	650 r.p.m.
Drill 4.60	550 r.p.m.
Countersink Drill	350 r.p.m.

Drilling Sequence

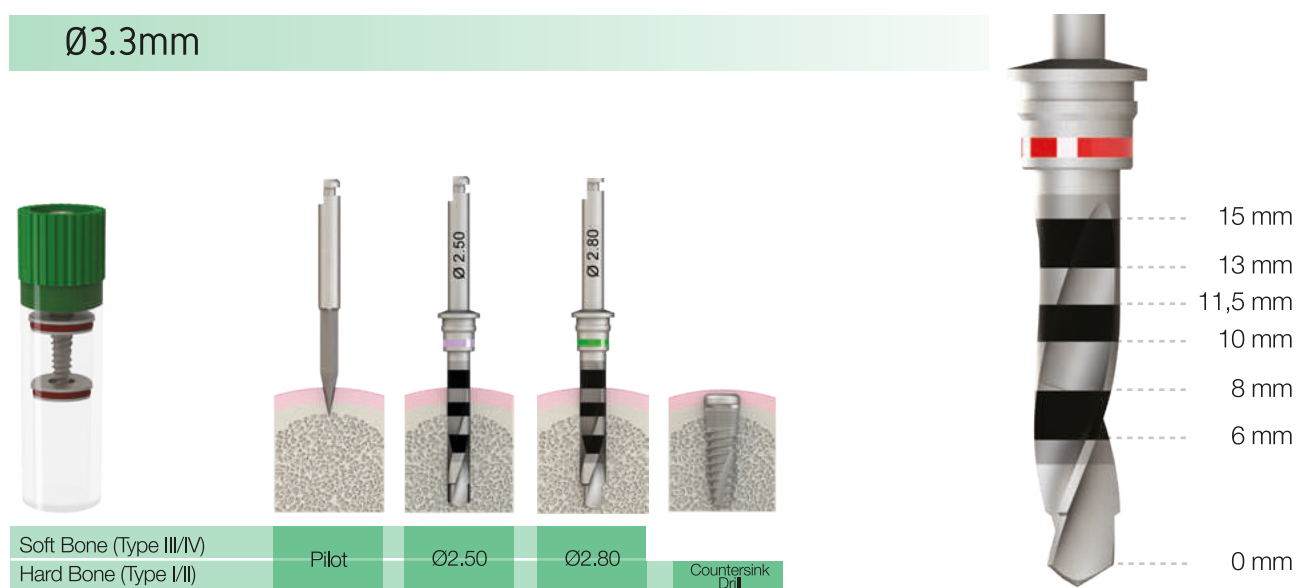

Drills are 1mm longer than the implants

Surgical Protocol Vulkan® Internal Hex.

Ø3.75mm

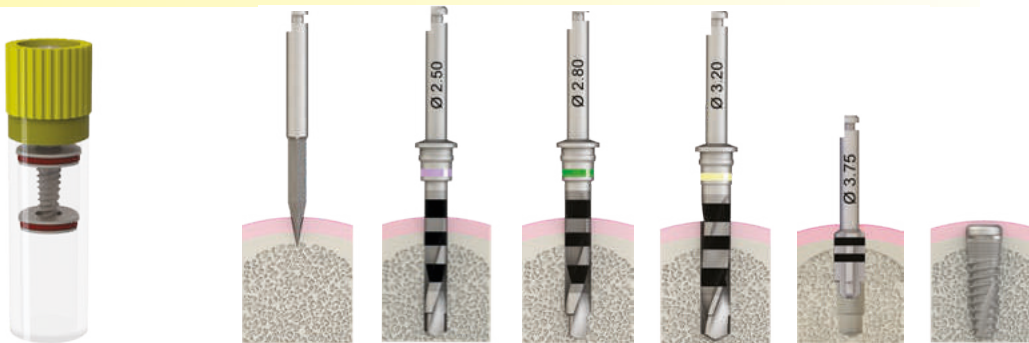

Soft Bone (Type III/IV)						
Hard Bone (Type I/II)	Pilot	Ø2.00	Ø2.80	Ø3.20	Countersink Drill	

Ø4.2mm

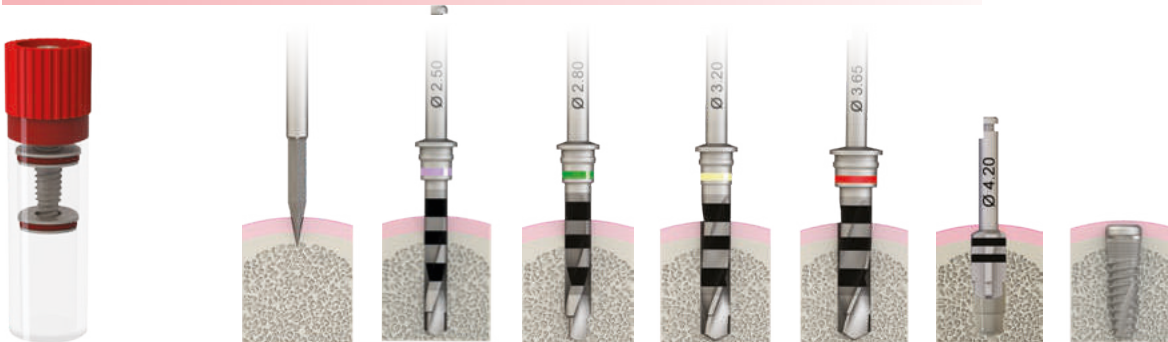

Soft Bone (Type III/IV)						
Hard Bone (Type I/II)	Pilot	Ø2.00	Ø2.80	Ø3.20	Ø3.65	Countersink Drill

Ø5.0mm

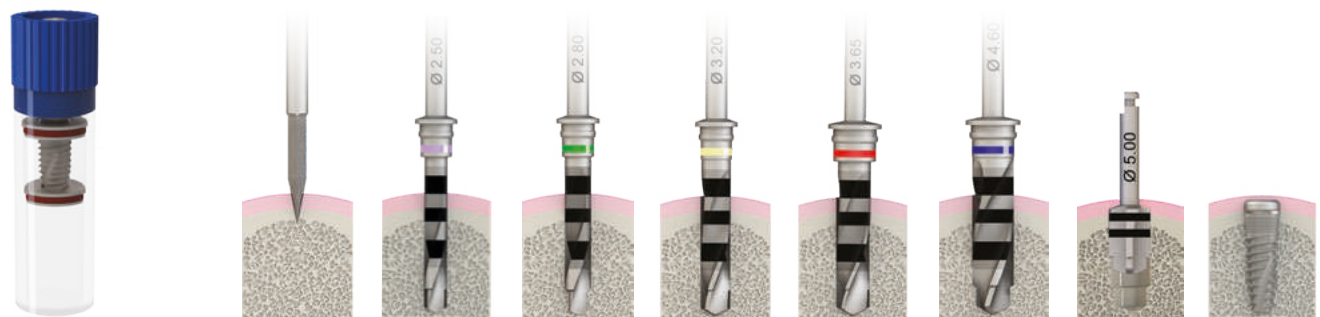

Soft Bone (Type III/IV)							
Hard Bone (Type I/II)	Pilot	Ø2.00	Ø2.80	Ø3.20	Ø3.65	Ø4.60	Countersink Drill

Smart Implant Driver Vulkan® External Hex.

Multifunctionality

✓ Implant insertion

✓ Transports the implant by friction fit

✓ Colocación del tapón de cierre mediante la punta hexagonal de 0.9 mm.

Titanium holders



✓ Places the cover screw with its 0,9mm hexagonal tip.



Contra-Angle Driver

Short (21 mm.) Long (27 mm.)

NP VEXTDRN1 VEXTDRN2
RP VEXTDRR1 VEXTDRR2

Ratchet Driver

Short (21 mm.) Long (27 mm.)

NP VEXTDRN3-R VEXTDRN4-R
RP VEXTDRR3-R VEXTDRR4-R

Squared Ratchet 4x4mm

Short (21 mm.) Long (27 mm.)

NP VEXTDRN1 VEXTDRN2
RP VEXTDRR1 VEXTDRR2



Step-by-Step Implant Placement Vulkan® Internal Hex.

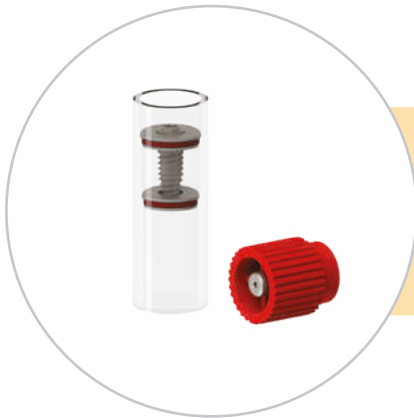

STEP 1

Lift off the coloured cap to open the vial containing the implant. Place the cap into a sterile field. The implant cover screw comes attached to the top of the cap.

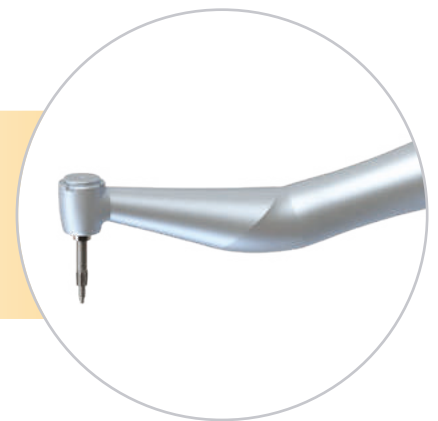

STEP 2

Attach the implant driver to the contra angle.



STEP 3

Connect the contra angle driver to the implant by exerting slight axial pressure. They will remain attached because the driver presents an elastic retention feature (rubber dots) in the area that connects to the implant. Remove the implant from the vial and carry it to the implant bed.

STEP 4

Begin inserting the implant with the contra angle set at low speed
10-15 rpm at 30-35 Ncm

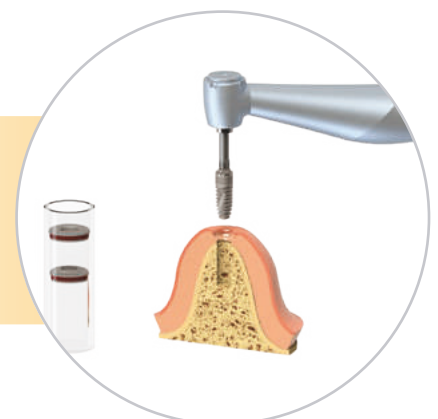

Step-by-Step Implant Placement Vulkan® Internal Hex.

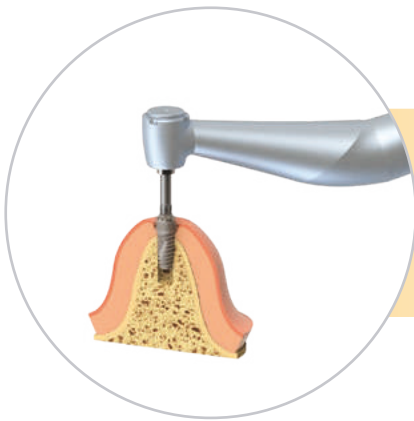

STEP 5
Insert the implant 75% of its length,
maximum torque 30-35 Ncm

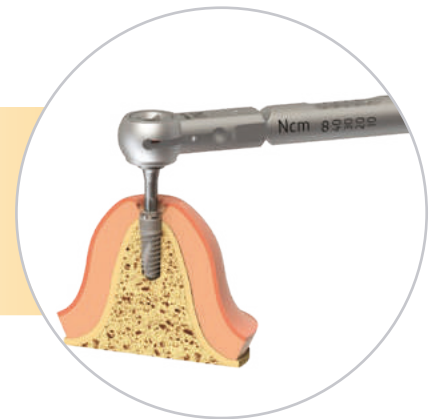

STEP 6
Finalize the implant installation manually, preferably
with the dynamometric ratchet at maximum torque
set to 40-45 Ncm



STEP 7
Remove the cover screw from the vial cap
with the Unigrip hand driver.

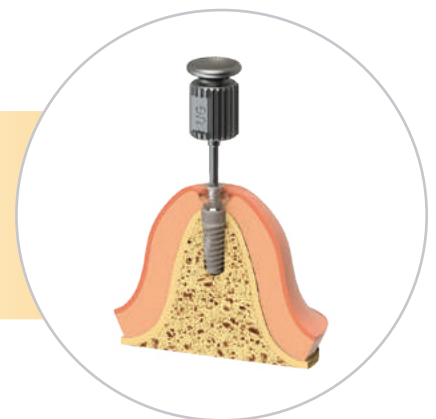

STEP 8
Hand-tight the Cover screw into the implant manually
It is recommended not to exceed a torque of 10 Ncm.

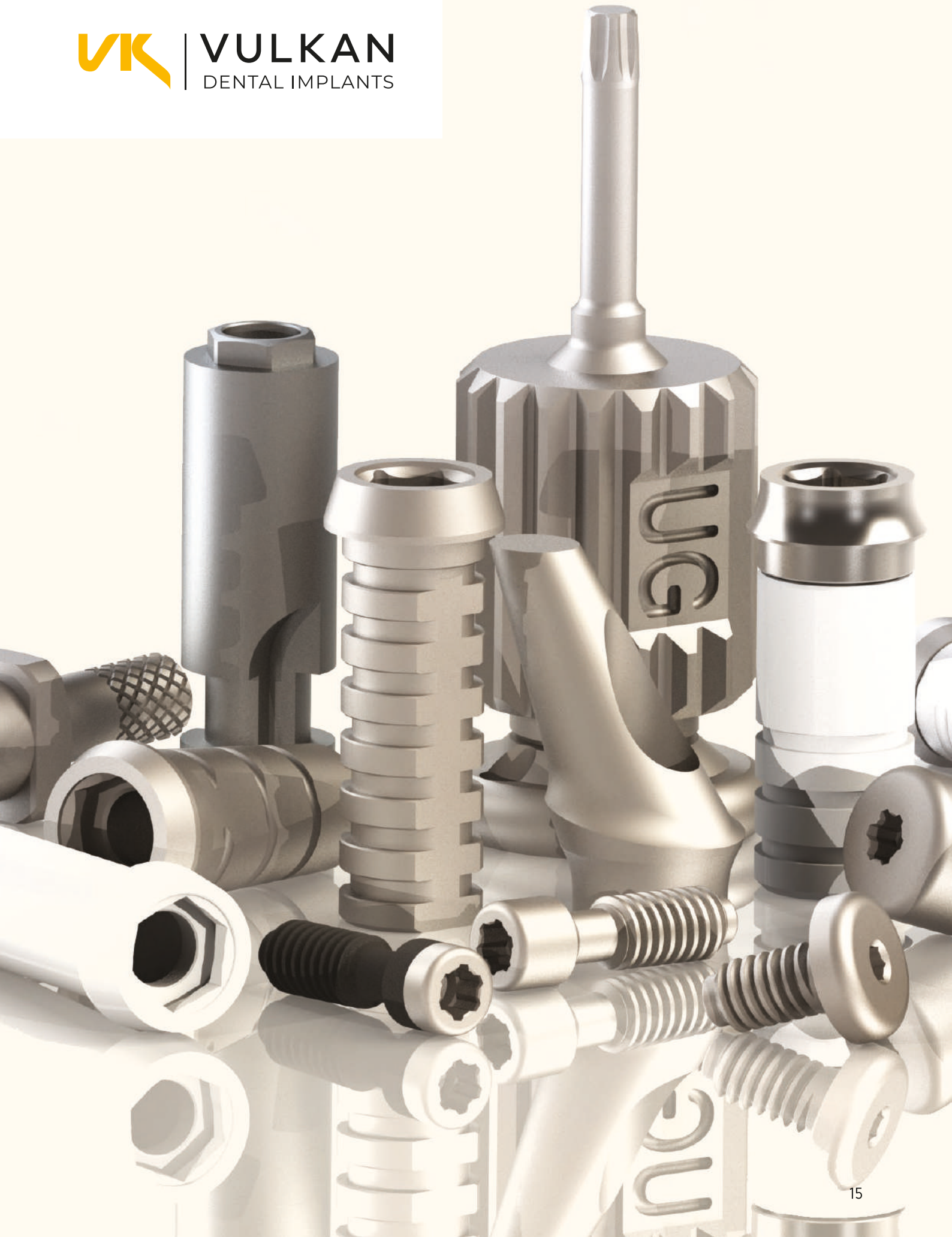

Vulkan® Internal Hex., Prosthetic Solutions and Tools

Introduction

Reliable and innovative prosthetic solutions ensure the **perfect fit** and maximum **robustness**.

As a result of our advanced manufacturing process, we obtain a tolerance of **only 5 µm**, guaranteeing a **perfect and extremely accurate sealed connection** of the prosthetic components.

Index

Prosthetic Solutions and Tools

-	Main Components	17-18
-	Transepithelial Multi-Use® System	19-20
-	Overdenture VulkanLoc® System	21
-	CAD-CAM Components	22
-	Surgical and Prosthetic Tools - Surgical kit	23



Single Prosthetic Driver

All Vulkan® External Hex prosthetic components work with the Unigrip Hand or Contra-Angle Driver (except for the Straight Multi-Use® Abutment and the VulkanLoc® system).

Main Prosthetic Components



Healing

Healing Cap (Grade 5 Titanium)

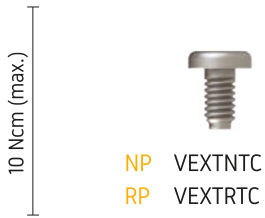

NP VEXTNTC
RP VEXTRTC

10 Ncm (max.)

Healing Cap Ø3.5 (NP) - Ø4.1 (RP) (Grade 5 Titanium)



h2.0 mm
NP -
RP VEXT01R2041

h3.0 mm
VEXT01N3035
VEXT01R3041

h4.0 mm
-
VEXT01R4041

h5.0 mm
VEXT01N5035
VEXT01R5041

20 Ncm (max.)

Healing Cap Ø4.5 (NP) - Ø5.0 (RP) (Grade 5 Titanium)



h2.0 mm
NP -
RP VEXT01R2050

h3.0 mm
VEXT01N3045
VEXT01R3050

h4.0 mm
-
VEXT01R4050

h5.0 mm
VEXT01N5045
VEXT01R5050

Impression

Impression Coping (Grade 5 Titanium)



Open Tray
NP VEXT02N0001
RP VEXT02R0001



Close Tray
-
VEXT02R0002

Analog (Stainless steel)



NP VEXT03N0000
RP VEXT03R0000

Screw Retained Restoration

Castable (POM C)



	Non-Engaging	Engaging
NP	VEXT04N0001	VEXT04N0002
RP	VEXT04R0001	VEXT04R0002

Cobalt-Chrome Castable (CrCo + POM C)



	Non-Engaging	Engaging
NP	VEXT05N0001	VEXT05N0002
RP	VEXT05R0001	VEXT05R0002

Temporary Abutment (Grade 5 Titanium)



	Non-Engaging	Engaging
NP	VEXT06N0001	VEXT06N0002
RP	VEXT06R0001	VEXT06R0002

Cemented Restoration

Straight Abutment (Grade 5 Titanium)



h1.0 mm

NP	VEXT07N1001
RP	VEXT07R1001

Angled Abutment (Grade 5 Titanium)



15° h1.0 mm

NP	VEXT07N1515
RP	VEXT07R1515



25° h2.0 mm

-	VEXT07R2025
---	-------------

Clinical Screw (Grade 5 Titanium)

(Unigrip Connection)



Titanium DLC
NP VEXT09N07T
RP VEXT09R07T



Titanium
NP VEXT09N07
RP VEXT09R07

30 Ncm (max.)

Prosthesis Screwed Angled



Non-Engaging - 17°
1- VCHA170001
2- VEXT05N0003



Engaging - 17°
1- VCHA170001
2- VEXT05N0004



Non-Engaging - 30°
1- VCHA300001
2- VEXT05R0003



Engaging - 30°
1- VCHA300001
2- VEXT05R0004

Angled Clinical Screw (Grade 5 Titanium)

(Tetralobular Connection)



Titanium
NP VEXT09N00-TLB
RP VEXT09R00-TLB



Short
VSDTLB-1

Medium
VSDTLB-2

Long
VSDTLB-3

30 Ncm (max.)

Transepithelial Multi-Use®



Multi-Use® Abutments

Straight Multi-Use® Abutment (Grade 5 Titanium)

30 Ncm (max.)					
	h1.0 mm	h2.0 mm	h3.0 mm	h4.0 mm	h5.0 mm
NP	VEXT10N1000	VEXT10N2000	VEXT10N3000	-	-
RP	VEXT10R1000	VEXT10R2000	VEXT10R3000	VEXT10R4000	VEXT10R5000

Angled Multi-Use® Abutments (Grade 5 Titanium)

30 Ncm (max.)						
	17° h2.0 mm	17° h3.0 mm	17° h4.0 mm	30° h3.0 mm	30° h4.0 mm	30° h5.0 mm
NP	-	-	-	-	-	-
RP	VEXT10R2017	VEXT10R3017	VEXT10R4017	VEXT10R3030	VEXT10R4030	VEXT10R5030

Healing

Healing Cap for Multi-Use®



(Integrated Screw)

Titanio
MU0102

Impression

Impression Coping for Multi-Use® (Grade 5 Titanium)



Open Tray
MU0211



Close Tray
MU0202

Multi-Use® Analog (Stainless steel)



MU03

Screw Retained Restoration

Castable Multi-Use® (POM C) Cobalt-Chrome Castable Multi-Use® (CrCo + POM C) Temporary Abutment Multi-Use®



MU0402



MU0502



Titanium
MU0602



PEEK
MU0602P

15 Ncm (max.)



Titanium DLC
MU0905T



Titanium
MU0905

Clinical Screw Multi-Use®

(Titanio Grado 5)

Prosthesis Screwed Angled Multi-Use®



1- VCHA170001
2- MU0504



1- VCHA300001
2- MU0504

Angled Clinical Screw Multi-Use®

Tetralobular Connection

15 Ncm (max.)



Titanium
MU0900-TLB



Short
VSDTLB-1

Medium
VSDTLB-2

Long
VSDTLB-3

Straight Driver Multi-Use®



Contra-Angle
VDMU-1



Ratchet
VDMU-2



Straight Mounter
Multi-Use®
VDMU-4

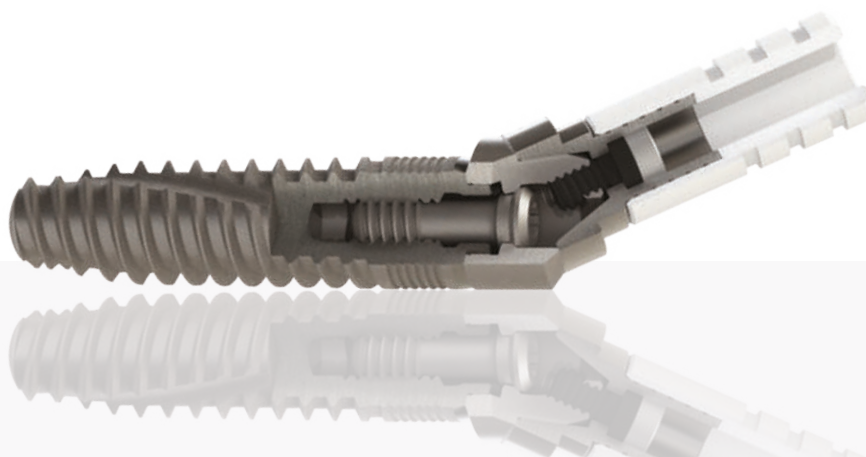

Overdenture VulkanLoc®



VulkanLoc® Abutment (Grade 5 Titanium + TiN Coating)

30 Ncm (max.)

	±0.7mm	2mm	3mm	4mm	5mm	6mm	1.5mm
	h1.0 mm	h2.0 mm	h3.0 mm	h4.0 mm	h5.0 mm	h6.0 mm	Soft Tissue
NP	VEXT11N1000	VEXT11N2000	VEXT11N3000	VEXT11N4000	VEXT11N5000	-	
RP	VEXT11R1000	VEXT11R2000	VEXT11R3000	VEXT11R4000	VEXT11R5000	VEXT11R6000	

Retentions VulkanLoc®

<ul style="list-style-type: none"> Blue Ref: L0402 X4 (1.5 lbs) Pink Ref: L0403 X4 (3.0 lbs) Transparent Ref: L0404 X4 (5.0 lbs) 	<ul style="list-style-type: none"> Black Ref: L0400 X4 Red Ref: L0401 X4 (1.0 lbs) Orange Ref: L0405 X4 (2.0 lbs) Green Ref: L0407 X4 (4.0 lbs)
---	---

VulkanLoc® Processing Package

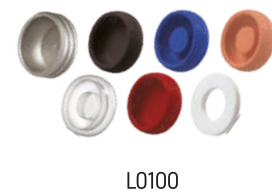

Housing with Black Retainer



VulkanLoc® Analog



Mounter for VulkanLoc®



Spacer Ring



Smart Tool VulkanLoc®



VDVL-3

Multi Functional Tool for VulkanLoc® System

VulkanLoc® Driver



Contra-Angle VDVL-1

Ratchet VDVL-2

Imp. Coping for VulkanLoc®



L0202

CAD-CAM Components

* Libraries Available:
www.vulkanimplants.com

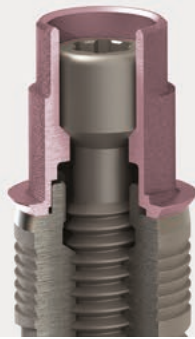

Ti-Base



Non - Engaging

NP h0.5 mm - VEXT08N0501

RP h1.5 mm - VEXT08R1501
h2.5 mm - VEXT08R2501
h3.5 mm - VEXT08R3501



Engaging

h0.5 mm - VEXT08N0502

h1.5 mm - VEXT08R1502
h2.5 mm - VEXT08R2502
h3.5 mm - VEXT08R3502

ScanBody Titanium



Extraoral

NP VEXT13N0002
RP VEXT13R0002

Analog (Stainless Steel.)



NP VEXT03N0010
RP VEXT03R0010

Ti-Base for transepithelial Multi-Use®



MU080502

ScanBody Multi-Use® Titanium



Intraoral
MU13R02

Analog Multi-Use® (Stainless Steel.)



MU0310

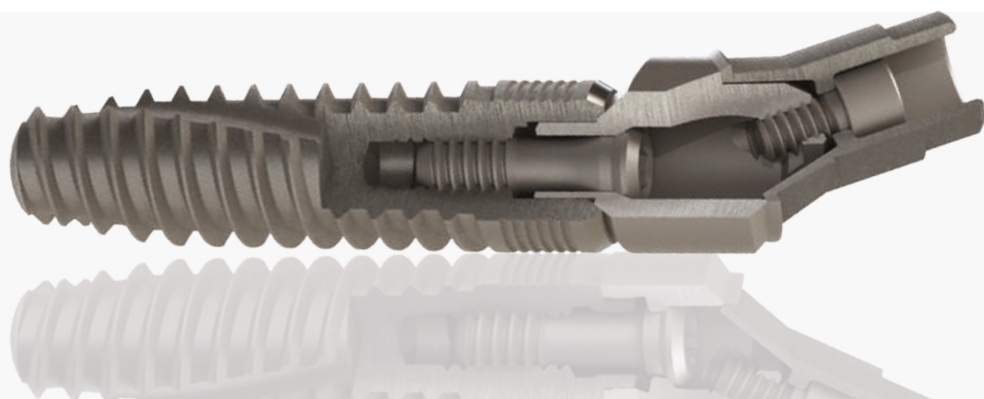

Surgical and Prosthetic Tools



Prosthetic Drivers Unigrip

Hand Driver/Ratchet $\varnothing 7.0$



Short VSDUG-1-R
Long VSDUG-2-R

Ratchet Driver 4x4



Short VDUG-1
Long VDUG-2

Contra-Angle



Short VSDUG-3
Long VSDUG-4

Adapters



VPL4X4
VSDCA

Tetralobular Drivers

Contra-Angle



Short VSDTLB-1
Medium VSDTLB-2
Long VSDTLB-3

Implant Driver Contra-Angle



Short NP VEXTDRN1
Long NP VEXTDRN2
RP VEXTDRR1 VEXTDRR2

Implant Driver 4x4 Ratchet



Short NP VEXTDRN3
Long NP VEXTDRN4
RP VEXTDRR3 VEXTDRR4

Implant Hand Driver/Ratchet $\varnothing 7.0$



Short NP VEXTDRN3-R
Long NP VEXTDRN4-R
RP VEXTDRN3-R VEXTDRN4-R

Spherical Drill



$\varnothing 5.0$
VSFD

Paralleling Pin



$\varnothing 2.0$
VG20

Drill Extender



VDL

Short Handle for Squard Driver 4mm



VMG4x4-S

Surgical Drills



Pilot VFP

$\varnothing 2.5$
VFT25

$\varnothing 2.8$
VFT28

$\varnothing 3.2$
VFT32

$\varnothing 3.65$
VFT365

$\varnothing 4.60$
VFT460

$\varnothing 3.75$
VFAV375

$\varnothing 4.20$
VFAV420

$\varnothing 5.00$
VFAV500

Drill Stoppers

Serie 1 for drills:
 $\varnothing 2.50$ / $\varnothing 2.80$ / $\varnothing 3.20$

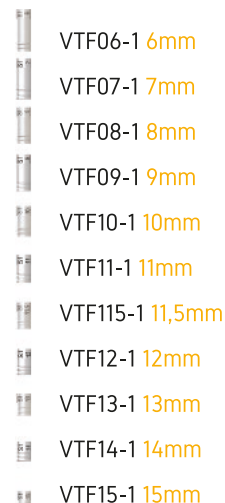

VTF06-1 6mm

VTF07-1 7mm

VTF08-1 8mm

VTF09-1 9mm

VTF10-1 10mm

VTF11-1 11mm

VTF115-1 11,5mm

VTF12-1 12mm

VTF13-1 13mm

VTF14-1 14mm

VTF15-1 15mm

Serie 2 for drills:
 $\varnothing 3.65$ / $\varnothing 4.60$

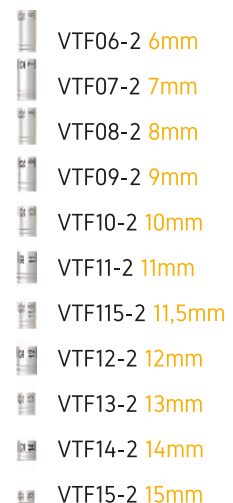

VTF06-2 6mm

VTF07-2 7mm

VTF08-2 8mm

VTF09-2 9mm

VTF10-2 10mm

VTF11-2 11mm

VTF115-2 11,5mm

VTF12-2 12mm

VTF13-2 13mm

VTF14-2 14mm

VTF15-2 15mm



Surgical and Prosthetic Tools



*Stoppers



VSK-EXT
Dynamometric ratchet VDIN2
Drivers Ø7 connection
Drill Stoppers not included

VSK-EXT-T
Dynamometric ratchet VDIN2
Drivers Ø7 connection
Drill Stoppers included

VSK2-EXT
Dynamometric ratchet VDIN
Drivers 4x4 connection
Drill Stoppers not included

VSK2-EXT-T
Dynamometric ratchet VDIN
Drivers 4x4 connection
Drill Stoppers included



Dynamometric ratchet
VDIN2



Spring Ratchet
VDIN

VULKAN® SURGICAL KIT CONTAINS

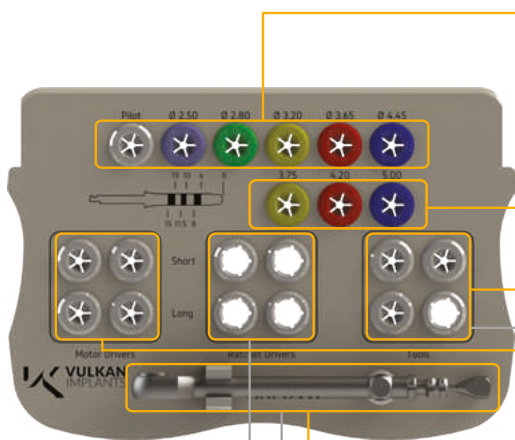

- VFP Vulkan® Pilot Drill
- VFT 25 Vulkan® Drill Ø 2.5
- VFT28 Vulkan® Drill Ø 2.8
- VFT32 Vulkan® Drill Ø 3.2
- VFT365 Vulkan® Drill Ø 3.65
- VFT445 Vulkan® Drill Ø 4.45
- VFAV375 Vulkan® Countersink Drill Ø3.75
- VFAV420 Vulkan® Countersink Drill Ø4.20
- VFAV500 Vulkan® Countersink Drill Ø5.00
- VG2028 Vulkan® Paralleling Pin Ø2.0/2.8
- VG20320 Vulkan® Paralleling Pin Ø2.0/3.2
- VDL Vulkan® Drill Extender
- VSDUG-2-R Vulkan® Prosthetic Hand / Unigrip Ratchet Long
- VEXTDRN3-R Vulkan® External Hex. NP Implant Driver Hand / Ratchet Short
- VEXTDRN4-R Vulkan® External Hex. NP Implant Driver Hand / Ratchet Long
- VEXTDRR3-R Vulkan® External Hex. RP Implant Driver Hand / Ratchet Short
- VEXTDRR4-R Vulkan® External Hex. RP Implant Driver Hand / Ratchet Long
- VDIN2 Dynamometric Ratchet 10-70 Ncm (4x4 / Ø 7)

BASIC VERSION WITH 4X4 DRIVERS

- VDUG-2 Vulkan® Unigrip Ratchet Long
- VEXTDRN1 Vulkan® External Hex. NP Implant Driver Contra-Angle Short
- VEXTDRN2 Vulkan® External Hex. NP Implant Driver Contra-Angle Long
- VEXTDRR1 Vulkan® External Hex. RP Implant Driver Contra-Angle Short
- VEXTDRR2 Vulkan® External Hex. RP Implant Driver Contra-Angle Long
- VDIN Vulkan® Spring Ratchet

Innovation,
Precision
and Quality



R&D+i

Our Research, Development and Innovation team is made up of **engineers and doctors** with long, extensive and successful experience in the development of dental implants and prosthetic components.

Together, they investigate and design the Vulkan® Implants **innovative products** according to user needs under the most **advanced protocols of Medical Engineering** and in accordance with **UNE 166002**.

STATE-OF-THE-ART-TECHNOLOGY

Vulkan® products are known for their **high precision, quality and robustness**. This is possible, among other things, thanks to the **skillfulness of our specialists**, experts in dental technology, and the latest CNC machinery which allow us to guarantee **tolerances of only 5 µm**.

We can proudly say that our products are manufactured with **the most accurate technological system in the world**.

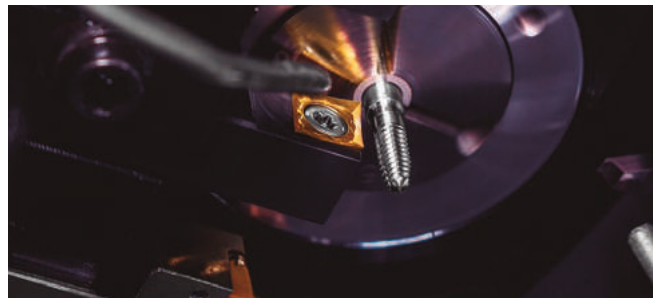

BEST QUALITY GUARANTEED

Our Quality Control Department applies the more **rigorous control system** and has been certified under the most strict European quality standards. Robotized computer machines with **artificial vision** analyze and ensure the precise measurement of each implant and prosthetic component. Also, through an innovative **optical laser** technology, we inspect up to the most micrometric detail of the implants or prosthetic components. Finally, to ensure the perfect functionality of our product, our team physically check the perfect fit of each item. **100% unitary control**.

European Quality Standards

ISO 9001



ISO 13485



IQNet



CE Marking



AEMPS Licence



Science

Vulkan®, Committed to Science

- ✓ Scientific collaboration with universities.
- ✓ **Clinical cases** with **private collaborators** demonstrate our reliability and effectiveness.
- ✓ **Scientific committee** made up of prestigious doctors:



Dr. Samir Aboul-Hosn

Maxillofacial Surgery Specialist

Dr. Samir Aboul-Hosn, medical specialist in Maxillofacial Surgery, obtained the degree of Doctor of Medicine with "Excellent Cum Laude" for his work on "3D technology applied to Orthognathic Surgery" at the International University of Catalonia. Currently, he is the **Scientific Director of Vulkan Implants**, supervising and collaborating closely on product design. In the healthcare field, he is the Head of the Oral and Maxillofacial Surgery Unit at Plató Hospital in Barcelona. Dr. Aboul-Hosn works intensively at the International University of Catalonia where he is a hired Professor, a position that gives him the title of a Degree subject, the Co-Direction of the International Master in Oral Surgery (IMOS) and the direction of various research studies. The European Council of Oro-Maxillo-Facial Surgery (EBOMFS) should also be highlighted on his CV as recognition of European level specialist degree, as well as the publication of several scientific articles in national and international journals.



Dr. Manuel Piñera

Implantology and dental prosthetics

Dr. Manuel Piñera has proven experience in implant surgery and prosthetics. His meritorious professional career is distinguished by his dedication to teaching and research in different universities such as the UB and the UIC for more than 20 years. At the same time, he has worked as an oral surgeon in private practice, becoming a professional of reference.



Dr. Octavi Ortiz Puigpelat

Implantology and dental prosthetics

Dr. Octavi Ortiz is a modern professional expert in Implantology and dental prosthetics who practices in prestigious private clinics in Barcelona. Author of publications and papers at national and international level, his work extends to the academic field, being Associate Professor of the International Master of Oral Surgery (UIC).

Clinical Cases
Vulkan®

CASE CCVINH1501

Before

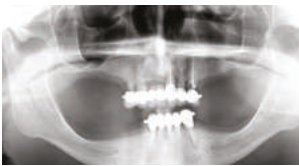

After

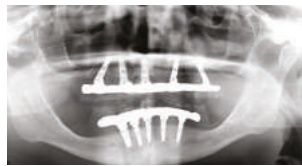

4 month after surgery



1 year after surgery

CASE CCVINH1502

Before



After

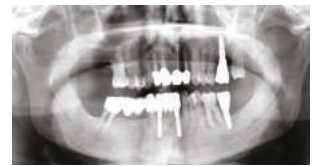

4 month after surgery



1 year after surgery

CASE CCVINH1503

Before

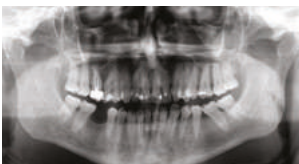

After

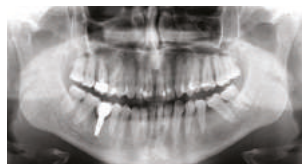

4 month after surgery



1 year after surgery

CASE CCVINH1601

Before



After



2 month after surgery



8 month after surgery

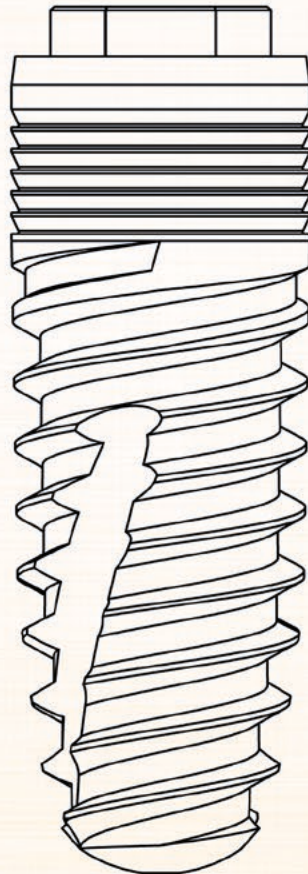

www.vulkanimplants.com

Vulkan® External Hex.



Titanimplant, S.L.
www.titanimplant.net

C/ General Manso, 28-38, Local 4
08980 Sant Feliu de Llobregat
Barcelona, España.

